

Refrigerated Air Dryer

For use in North, Central & South America



Protect Pneumatic Equipment from Moisture!

An air dryer removes the vapor from the moist compressed air delivered by the compressor, and prevents it from causing the pneumatic equipment to fail.

• Effects of moisture on equipment

Malfunctioning of valves and actuators caused by dripping grease

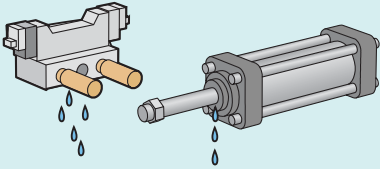

Decomposition of auto drain caused by rusting inside pipes

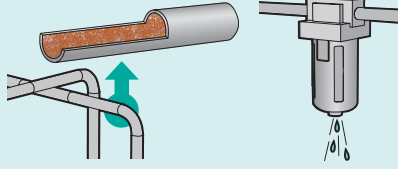

Generation of water droplets



Refrigerant

R134a(HFC), R407C(HFC)

Coefficient of destruction for ozone is zero.

Improved corrosion resistance with the use of stainless steel, plate type heat exchanger (IDFB4E to 75E)

UL certified product

Power supply voltage:

Single-phase 115 VAC (60 Hz)

230 VAC (60 Hz)

Three-phase 460 VAC (60 Hz)

New

IDFB55E/75E
are added



Series **IDFB□E**



CAT.ES30-10B

The Importance of Dryers

Compressed air contains moisture (water vapor, droplets), oil, debris and other foreign matter. Filters and mist separators can be used to remove droplets, oil, debris, and so on, but a dryer is necessary to remove water vapor.

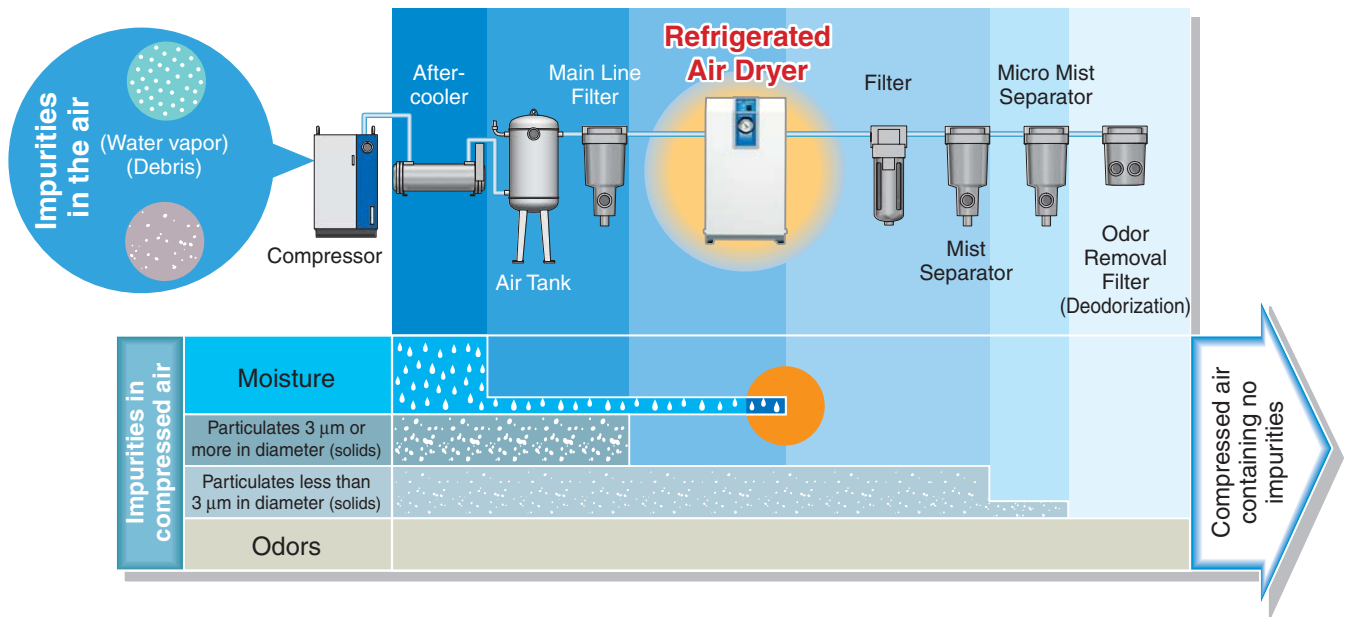

The primary job of a dryer is **dehumidification.**

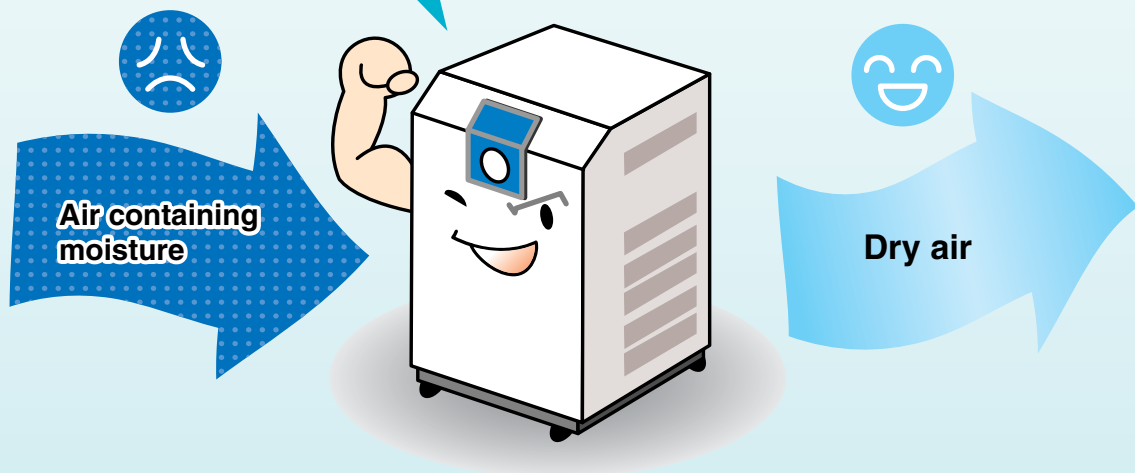

SMC Air Preparation Equipment

Quick Reference Guide to Air Preparation Equipment

- * Shows standard combinations. The suffix numbers of the model indicate port size, power supply, etc.
Refer to “How to Order” on pages 3 and 7 for details on dryers and refer to “SMC Best Pneumatics” Vol.14 catalog for other equipment.
- * The symbol “—” in the table indicates that no such equipment exists.
- * The figures for air flow capacity corresponding to air compressor output are provided for reference only.
- * The table below applies to the air pressure dew point (at 100 psi (0.7 MPa)) 50°F (10°C). In cases where other dew points are needed, please refer to page 2 (Model Selection) of this catalog.

For reciprocating compressors

Air compressor			Main line			Sub line		Local line				
Output (kW)	Air flow capacity		Air tank	Aftercooler ^{Note 1)}		Main line filter	Refrigerated air dryer ^{Note 2)} 60 Hz area	Mist separator	Micro mist separator with pre-filter	Micro mist separator	Super mist separator	Odor removal filter
	SCFM (ANR)	m ³ /h (ANR)		Air-cooled	Water-cooled							
2.2	10.6	18	AT6C-04	HAA7-06	HAW7-06	AFF2C-02	IDFB3E	AM150C-02	AMH250C-03	AMD250C-03	AME250C-03	AMF250C-03
3.7	17.7	30	AT6C-04	HAA7-06	HAW7-06	AFF4C-03	IDFB4E	AM250C-03	AMH250C-03	AMD250C-03	AME250C-03	AMF250C-03
5.5	24.7	42	AT6C-04	HAA7-06	HAW7-06	AFF4C-04	IDFB6E	AM250C-03	AMH350C-04	AMD350C-04	AME350C-04	AMF350C-04
7.5	35.3	60	AT11C-06	HAA15-10	HAW22-14	AFF8C-04	IDFB8E	AM350C-04	AMH350C-04	AMD350C-04	AME350C-04	AMF350C-04
11	53.0	90	AT11C-06	HAA15-10	HAW22-14	AFF8C-06	IDFB11E	AM350C-06	AMH450C-06	AMD450C-06	AME450C-06	AMF450C-06
15	70.6	120	AT22C-14	HAA22-14	HAW22-14	AFF11C-06	IDFB15E	AM450C-06	AMH450C-06	AMD450C-06	AME450C-06	AMF450C-06
22	105.9	180	AT22C-14	HAA37-14	HAW37-14	AFF22C-10	IDFB22E	AM550C-10	AMH550C-06	AMD550C-10	AME550C-10	AMF550C-10
27	123.6	210	AT37C-14	HAA37-14	HAW37-14	AFF22C-10	IDFB22E	AM550C-10	AMH550C-10	AMD550C-10	AME550C-10	AMF550C-10
37	176.5	300	AT37C-14	—	HAW55-20	AFF37B-14	IDFB37E	AM650-14	AMH650-14	AMD650-14	AME650-14	AMF650-14
55	264.7	450	AT55C-20	—	HAW75-20	AFF75 _B -20	IDFB55E	AM850-20	AMH850-20	AMD850-20	AME850-20	AMF850-20
75	353.0	600	AT75C-20	—	HAW110-30	AFF75 _B -20	IDFB75E	AM850-20	AMH850-20	AMD850-20	AME850-20	AMF850-20

For screw compressors (when an aftercooler is installed)

Air compressor			Main line		Sub line	Local line				
Output (kW)	Air flow capacity		Aftercooler ^{Note 1)}		Refrigerated air dryer ^{Note 2)} 60 Hz area	Mist separator	Micro mist separator with pre-filter	Micro mist separator	Super mist separator	Odor removal filter
	SCFM (ANR)	m ³ /h (ANR)	Air-cooled	Water-cooled						
2.2	10.6	18	HAA7-06	HAW2-04	IDFB3E	AM150C-02	AMH250C-03	AMD250C-03	AME250C-03	AMF250C-03
3.7	17.7	30	HAA7-06	HAW7-06	IDFB4E	AM250C-03	AMH250C-03	AMD250C-03	AME250C-03	AMF250C-03
5.5	26.5	45	HAA7-06	HAW7-06	IDFB6E	AM250C-03	AMH350C-04	AMD350C-04	AME350C-04	AMF350C-04
7.5	35.3	60	HAA7-06	HAW7-06	IDFB8E	AM350C-04	AMH350C-04	AMD350C-04	AME350C-04	AMF350C-04
11	53.0	90	HAA15-10	HAW22-14	IDFB11E	AM350C-04	AMH450C-06	AMD450C-06	AME450C-06	AMF450C-06
15	77.7	132	HAA15-10	HAW22-14	IDFB15E	AM450C-06	AMH550C-10	AMD550C-10	AME550C-10	AMF550C-10
22	116.5	198	HAA22-14	HAW22-14	IDFB22E	AM550C-10	AMH550C-10	AMD550C-10	AME550C-10	AMF550C-10
37	204.7	348	HAA37-14	HAW37-14	IDFB37E	AM650-14	AMH650-14	AMD650-14	AME650-14	AMF650-14
55	300.0	510	—	HAW55-20	IDFB55E	AM850-20	AMH850-20	AMD850-20	AME850-20	AMF850-20
75	423.5	720	—	HAW75-20	IDFB75E	AM850-20	AMH850-20	AMD850-20	AME850-20	AMF850-20



Note 1) Air-cooled aftercooler
Water-cooled aftercooler

Note 2) Series IDFB

Inlet air temperature 158.8°F (60°C)
 Ambient temperature 84.7°F (32°C)
 Inlet air temperature 476.2°F (180°C)
 Cooling water inlet temperature 79.4°F (30°C)
 Inlet air temperature 100°F (37.8°C) Saturation
 Ambient temperature 84.7°F (32°C)

1. Standard Products

Series IDFB

Standard inlet air type

Rated inlet air temperature:
100°F (37.8°C)



Model	Air flow capacity SCFM (m³/h [ANR])			Refrigerant	Rated inlet condition	Port size
	Outlet air pressure dew point ^{Note}					
	37°F (2.8°C)	45°F (7.2°C)	50°F (10°C)			
IDFB3E	10 (17)	11 (19)	12 (20)	R134a (HFC)	100°F (37.8°C) 100 psi (0.7 MPa)	NPT 3/8
IDFB4E	15 (25)	16 (27)	17 (28)			NPT 1/2
IDFB6E	25 (43)	26 (45)	28 (47)			NPT 3/4
IDFB8E	41 (70)	43 (74)	45 (77)			NPT 1
IDFB11E	59 (100)	62 (106)	65 (110)			NPT 1 1/2
IDFB15E	71 (120)	80 (136)	86 (147)			NPT 2
IDFB22E	107 (182)	120 (205)	130 (221)			
IDFB37E	161 (273)	173 (294)	181 (308)			
IDFB55E	226 (384)	258 (438)	297 (504)	R407C (HFC)		
IDFB75E	300 (510)	353 (600)	406 (690)			

Note) Air flow capacity for each dew point is indicated.

Page

P. 3 to 9

2. Options

Optional specifications	Applicable model	Model (Suffix: Option symbol)
Cool compressed air output	IDFB3E to 11E	IDFB□E-11-A
For medium air pressure (up to 240 psi (1.6 MPa)) (Auto drain bowl: Metal bowl with level gauge)	IDFB6E to 37E	IDFB□E-□-K
With heavy duty auto drain (Suitable for medium air pressure)	IDFB55E, 75E	IDFB□E-46-L
With circuit breaker	IDFB4E to 75E	IDFB□E-□-R
With terminal block for power supply, run & alarm signal and remote operation	IDFB4E to 75E	IDFB□E-□-T
Timer type solenoid valve with auto drain (Suitable for medium air pressure)	IDFB4E to 75E	IDFB□E-□-V

Page

P. 10, 11

3. Accessory (Option)

Description	Page
Dust-protecting filter set	P. 12

4. Safety Instructions ... Back page 1, 2

Series IDFB□E

Model Selection

The corrected air flow capacity, which considers the user's operating conditions, is required for selecting the air dryer. Please select using the following procedures.

1 Read the correction factor.

Obtain the correction factor A to D suitable for your operating condition using the table below.

2 Calculate the corrected air flow capacity.

Obtain the corrected air flow capacity from the following formula.
Corrected air flow capacity = Air consumption ÷ (Correction factor A x B x C)

3 Select the model.

Select the model which air flow capacity exceeds the corrected air flow capacity using the specification table. (For air flow capacity, refer to the data D below.)

4 Option

5 Finalize the model number.

6 Select accessories sold separately.

IDFB□E Selection Example

Condition	Data symbol	Correction factor ^{Note)}
Inlet air temperature	110°F (43°C)	A 0.82
Ambient temperature	105°F (40.5°C)	B 0.98
Inlet air pressure	75 psi (0.53 MPa)	C 0.95
Air consumption	14 SCFM	—

Note) Values obtained from the table below.

$$\text{Corrected air flow capacity} = 14 \text{ SCFM} \div (0.82 \times 0.98 \times 0.95) = 18 \text{ SCFM}$$

According to the corrected air flow capacity of 18 SCFM, the **IDFB6E** will be selected because its air flow capacity at 60 Hz is 25 SCFM.

Refer to page 3, 7.

Refer to page 3, 7.

Refer to page 12.

Data A: Inlet Air Temperature

Inlet air temperature		Correction factor	
°F	°C	IDFB3E to 37E	IDFB55E, 75E
90	32	1.31	1.08
100	37.8	1.00	1.00
110	43	0.82	0.83
120	49	0.66	0.46

Data B: Ambient Temperature

Ambient temperature		Correction factor
°F	°C	
77	25	1.24
90	32	1.09
95	35	1.04
100	37.8	1.00
105	40.5	0.98
110	43	0.95

Data C: Inlet Air Pressure

Inlet air pressure		Correction factor
psi	MPa	
75	0.53	0.95
100	0.70	1.00
110	0.76	1.04
120	0.83	1.07
125	0.86	1.09
150	1.03	1.13
175	1.21	1.18
200	1.38	1.22
250	1.72	1.24

Data D: Air Flow Capacity

Model		Air flow capacity SCFM (m ³ /h (ANR))									
		IDFB3E	IDFB4E	IDFB6E	IDFB8E	IDFB11E	IDFB15E	IDFB22E	IDFB37E	IDFB55E	IDFB75E
Outlet air pressure dew point	37°F (2.8°C)	10 (17)	15 (25)	25 (43)	41 (70)	59 (100)	71 (120)	107 (182)	161 (273)	226 (384)	300 (510)
	45°F (7.2°C)	11 (19)	16 (27)	26 (45)	43 (74)	62 (106)	80 (136)	120 (205)	173 (294)	258 (438)	353 (600)
	50°F (10°C)	12 (20)	17 (28)	28 (47)	45 (77)	65 (110)	86 (147)	130 (221)	181 (308)	297 (504)	406 (690)

Note) In case of "Option A (Cool compressed air output)", the air flow capacity is different. Refer to page 10 for details.

Refrigerant R134a (HFC) Standard Inlet Air

Series **IDFB** □ **E**

3E, 4E, 6E, 8E, 11E, 15E

(Inlet air temperature: 100°F [37.8°C])

How to Order

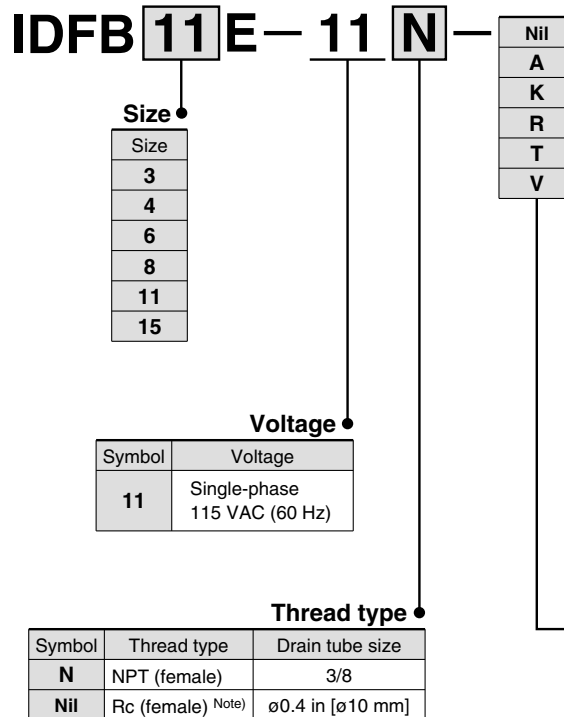

Note) An adapter for converting NPT to Rc is included if the thread symbol is "Nil".

Table of Options and Available Combinations (Size/Option)

Symbol ^{Note 1)}	Nil	A	K	R	T	V
Optional specifications	None	Cool compressed air output	For medium air pressure (Auto drain bowl: Metal case with level gauge)	With circuit breaker	With terminal block for run & alarm signal	Timer type solenoid valve with auto drain (Suitable for medium air pressure)
Size						
3	●	●	—	—	—	—
4	●	●	—	●	●	●
6	●	●	●	●	●	●
8	●	●	●	●	●	●
11	●	●	●	●	●	●
15	●	—	●	●	●	●

Note 1) Enter alphabetically when multiple options are combined. However, the following combination cannot be achieved.
• Combination of K and V (Only one or the other may be attached.)

Note 2) Refer to pages 10 and 11 for further information on options.

Standard Specifications

Specifications		Model	Standard inlet air				
		IDFB3E	IDFB4E	IDFB6E	IDFB8E	IDFB11E	IDFB15E
Operating ranges	Fluid	Compressed air					
	Inlet air temperature °F (°C)	41 to 122 (5 to 50)					
	Inlet air pressure psi (MPa)	22 (0.15) to 150 (1.0)					
	Ambient temperature °F (°C)	36 to 104 (2 to 40) Relative humidity of 85% or less					
Air flow capacity SCFM ^{Note 1, 2)} (m ³ /h (ANR))	Outlet air pressure dew point 37°F (2.8°C)	10 (17)	15 (25)	25 (43)	41 (70)	59 (100)	71 (120)
	Outlet air pressure dew point 45°F (7.2°C)	11 (19)	16 (27)	26 (45)	43 (74)	62 (106)	80 (136)
	Outlet air pressure dew point 50°F (10°C)	12 (20)	17 (28)	28 (47)	45 (77)	65 (110)	86 (147)
Rated conditions	Operating pressure psi (MPa)	100 (0.7)					
	Inlet air temperature °F (°C)	100 (37.8)					
	Ambient temperature °F (°C)	100 (37.8)					
Electric specifications	Power supply voltage	Single-phase 115 VAC [voltage fluctuation ±10%] 60 Hz					
	Operating current (A)	2.7	3.0	3.0	3.5	6.5	7.5
	Power consumption (W)	240	260	260	310	550	750
	Applicable circuit breaker capacity ^{Note 3)} (A)	15					
Condenser		Forced air-cooled					
Refrigerant		R134a (HFC)					
Thread symbol and size	Symbol N	NPT 3/8 (female)	NPT 1/2 (female)	NPT 3/4 (female)		NPT 1 (female)	
	Symbol Nil	Rc 3/8 (female) With Rc conversion adapter	Rc 1/2 (female) With Rc conversion adapter	Rc 3/4 (female) With Rc conversion adapter		Rc 1 (female) With Rc conversion adapter	
Drain tube O.D.	Symbol N	3/8 inch					
	Symbol Nil	10 mm					
Coating color		White 1					
Mass	lbs (kg)	40 (18)	55 (25)	57 (26)	64 (29)	73 (33)	110 (50)
Compliant standards		UL, CSA					

Note 1) ANR is under the conditions of 68°F (20°C) at atmospheric pressure and relative humidity of 65%.

Note 2) Air flow capacity for each outlet air pressure dew point is indicated.

Note 3) Install a circuit breaker with a sensitivity of 30 mA.

Note 4) If this equipment suffers a short-term power outage (even if it is only momentary), it may require some time before normal operation resumes, and protective mechanisms may prevent normal operation even after the power supply has been restored.

Replacement Parts

Model		IDFB3E	IDFB4E	IDFB6E	IDFB8E	IDFB11E	IDFB15E
Auto drain replacement part no. ^{Note 5)}	Thread symbol N	AD38N-Z			AD48N-Z		
	Thread symbol Nil	AD38			AD48		

Note 5) The part number for the auto drain components without including the body part. Body part replacement is impossible.

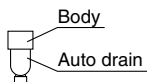

Construction Principle (Circuit for Air/Refrigerant)

Humid, hot air coming into the air dryer will be cooled down by a cooler (heat exchanger). Water condensed at this time will be removed from the air by a drain separator (auto drain) and drained out automatically. Air separated from the water will be heated by a re-heater (heat exchanger) to obtain the dried air, which goes through to the outlet side.

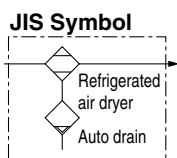
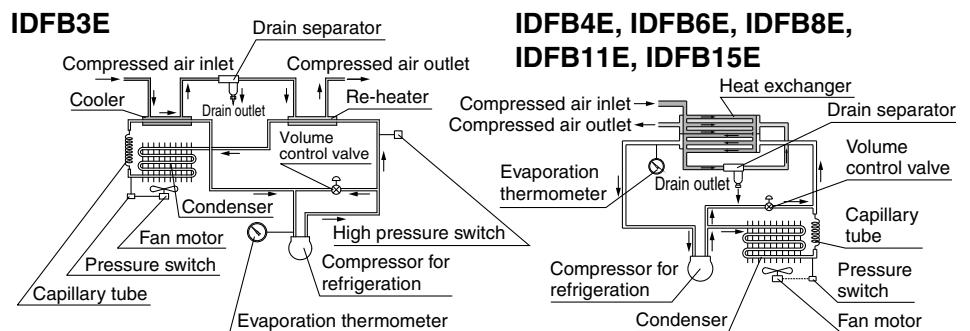

Series IDFB□E

Dimensions

IDFB3E

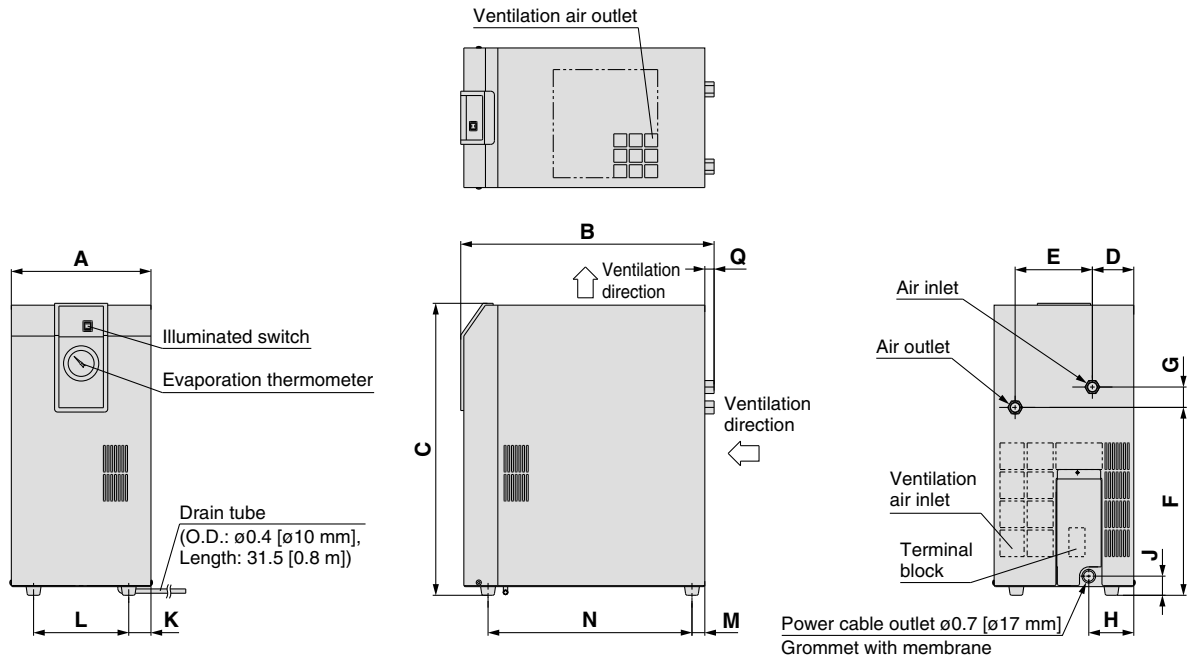

Dimensions

Model	Port size	A	B	C	D	E	F	G	H	J	K	L	M	N	Q
IDFB3E	3/8	8.9 [226]	16.1 [410]	18.6 [473]	2.6 [67]	4.9 [125]	12.0 [304]	1.3 [33]	2.9 [73]	1.2 [31]	1.4 [36]	6.1 [154]	0.8 [21]	13.0 [330]	0.6 [15]

Unit: inch [mm]

IDFB4E to IDFB11E

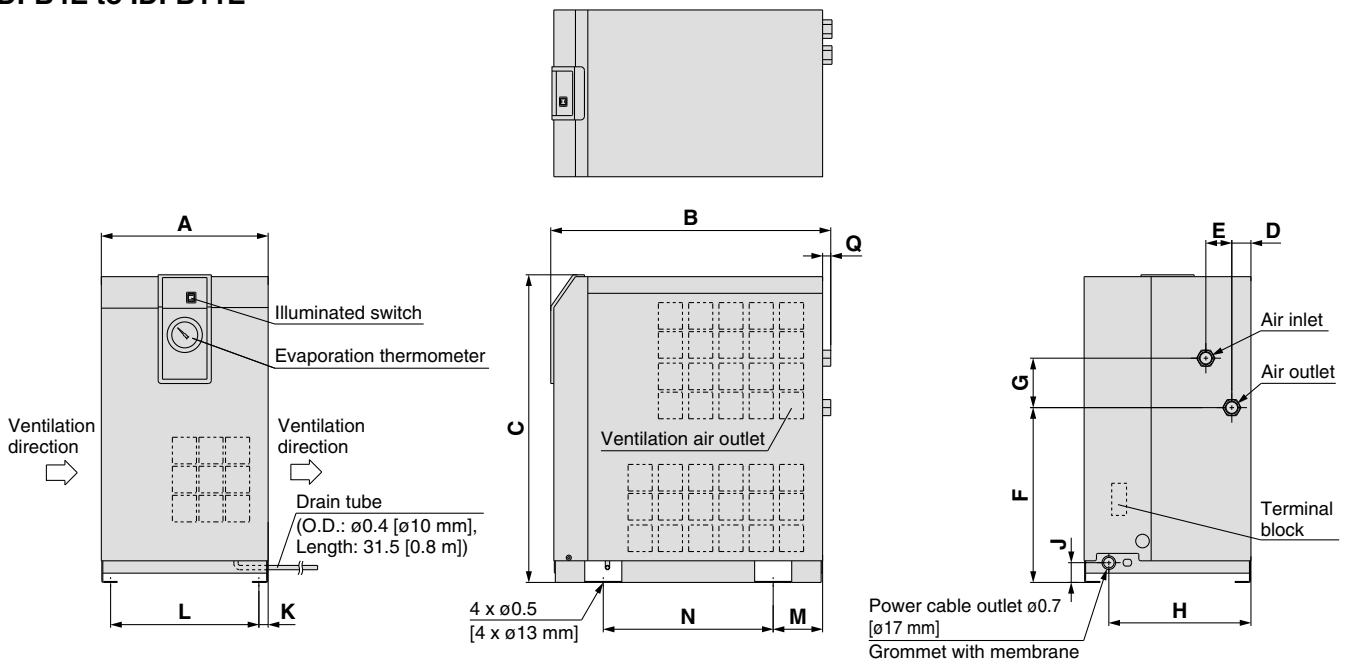

Dimensions

Model	Port size	A	B	C	D	E	F	G	H	J	K	L	M	N	Q
IDFB4E	1/2		17.8 [453]	19.6 [498]			11.1 [283]							10.8 [275]	
IDFB6E	3/4	10.6 [270]	17.9 [455]		1.2 [31]	1.7 [42]		3.1 [80]	9.1 [230]	1.3 [32]	0.6 [15]	9.4 [240]	3.1 [80]		0.5 [13]
IDFB8E			19.1 [485]	22.4 [568]			14 [355]							11.8 [300]	
IDFB11E															

Unit: inch [mm]

Dimensions

IDFB15E

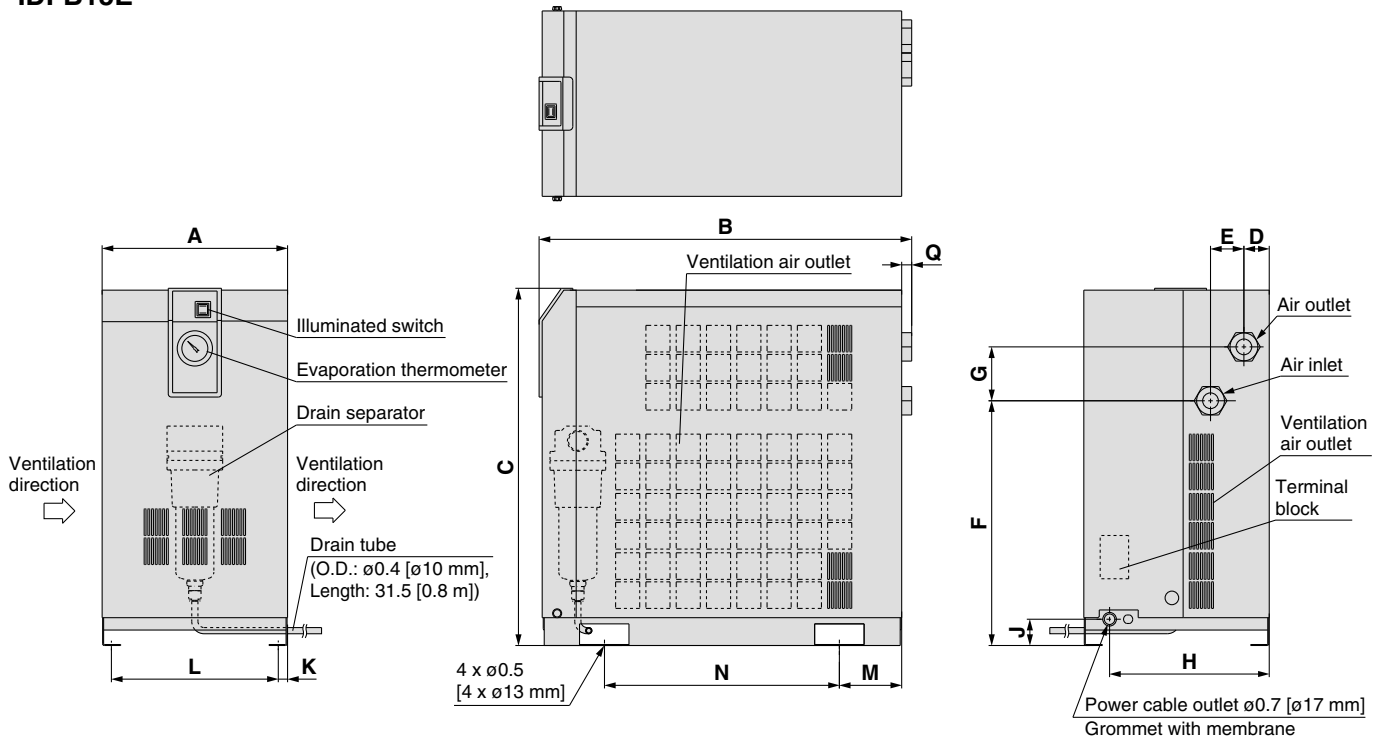

Dimensions

Unit: inch [mm]

Model	Port size	A	B	C	D	E	F	G	H	J	K	L	M	N	Q
IDFB15E	1	11.8 [300]	23.7 [603]	22.8 [578]	1.6 [41]	2.1 [54]	16.6 [396]	3.4 [87]	10.2 [258]	1.7 [43]	0.6 [15]	10.6 [270]	4.0 [101]	15.0 [380]	0.6 [16]

Refrigerant R134a (HFC), R407C (HFC) Standard Inlet Air

Series **IDFB** □ **E**

22E, 37E, 55E, 75E

(Inlet air temperature: 100°F [37.8°C])

How to Order

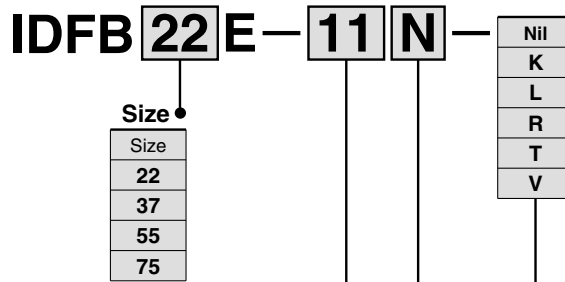

Voltage

Symbol	Voltage	Applicable size			
		22	37	55	75
11	Single-phase 115 VAC (60 Hz)	●	—	—	—
23	Single-phase 230 VAC (60 Hz)	●	●	—	—
46	Three-phase 460 VAC (60 Hz)	—	—	●	●

Thread type

Symbol	Thread type	Drain tube size
N	NPT (male)	3/8
Nil	R (male)	ø0.4 in [ø10 mm]

Table of Options and Available Combinations (Size/Option)

Symbol ^{Note 1)}	Nil	K	L	R	T	V
Optional specifications	None	For medium air pressure (Auto drain bowl: Metal case with level gauge)	With heavy duty auto drain (Suitable for medium air pressure)	With circuit breaker	With terminal block for run & alarm signal	Timer type solenoid valve with auto drain (Suitable for medium air pressure)
Size						
22	●	●	—	●	●	●
37	●	●	—	●	●	●
55	●	—	●	●	●	●
75	●	—	●	●	●	●

Note 1) Enter alphabetically when multiple options are combined.
However, the following combination cannot be achieved.

• Combination of K, L and V (All of them are auto drain and only one or the other may be attached.)

Note 2) Refer to pages 10 and 11 for further information on options.

Standard Specifications

Specifications		Standard inlet air			
		IDFB22E	IDFB37E	IDFB55E	IDFB75E
Operating ranges	Fluid	Compressed air			
	Inlet air temperature °F (°C)	41 to 122 (5 to 50)			
	Inlet air pressure psi (MPa)	22 (0.15) to 150 (1.0)			
	Ambient temperature °F (°C)	36 to 104 (2 to 40) Relative humidity of 85% or less			
Air flow capacity SCFM <small>(Note 1, 2)</small> (m ³ /h (ANR))	Outlet air pressure dew point 37°F (2.8°C)	107 (182)	161 (273)	226 (384)	300 (510)
	Outlet air pressure dew point 45°F (7.2°C)	120 (205)	173 (294)	258 (438)	353 (600)
	Outlet air pressure dew point 50°F (10°C)	130 (221)	181 (308)	297 (504)	406 (690)
Rated conditions	Operating pressure psi (MPa)	100 (0.7)			
	Inlet air temperature °F (°C)	100 (37.8)			
	Ambient temperature °F (°C)	100 (37.8)			
Electric specifications	Power supply voltage	Single-phase 115 VAC [voltage fluctuation ±10%] 60 Hz	Single-phase 230 VAC [voltage fluctuation ±10%] 60 Hz		Three-phase 460 VAC [voltage fluctuation ±10%] 60 Hz
	Operating current (A)	9	4.5	5.6	3.8
	Power consumption (W)	1000		1270	2400
	Applicable circuit breaker capacity <small>(Note 3)</small> (A)	15		10	
Condenser		Forced air-cooled			
Refrigerant		R134a (HFC)		R407C (HFC)	
Thread symbol and size	Symbol N	NPT 1 (male)	NPT 1½ (male)	NPT 2 (male)	
	Symbol Nil	R 1 (male)	R 1½ (male)	R 2 (male)	
Drain tube O.D.	Symbol N	3/8 inch			
	Symbol Nil	10 mm			
Coating color		White 1			
Mass	lbs (kg)	119 (54)	137 (62)	258 (117)	271 (123)
Compliant standards		UL, CSA			

Note 1) ANR is under the conditions of 68°F (20°C) at atmospheric pressure and relative humidity of 65%.

Note 2) Air flow capacity for each outlet air pressure dew point is indicated.

Note 3) Install a circuit breaker with a sensitivity of 30 mA.

Note 4) If this equipment suffers a short-term power outage (even if it is only momentary), it may require some time before normal operation resumes, and protective mechanisms may prevent normal operation even after the power supply has been restored.

Replacement Parts

Model		IDFB22E	IDFB37E	IDFB55E	IDFB75E
Auto drain replacement part no. <small>(Note 5)</small>	Thread symbol N	AD48N-Z			
	Thread symbol Nil	AD48			

Note 5) The part number for the auto drain components without including the body part. Body part replacement is impossible.

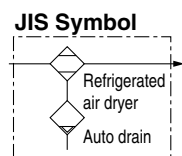
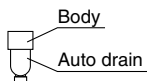

Construction Principle (Circuit for Air/Refrigerant)

Humid, hot air coming into the air dryer will be cooled down by a cooler re-heater (heat exchanger). Water condensed at this time will be removed from the air by a drain separator (auto drain) and drained out automatically. Air separated from the water will be heated by a cooler re-heater (heat exchanger) to obtain the dried air, which goes through to the outlet side.

IDFB22E, IDFB37E

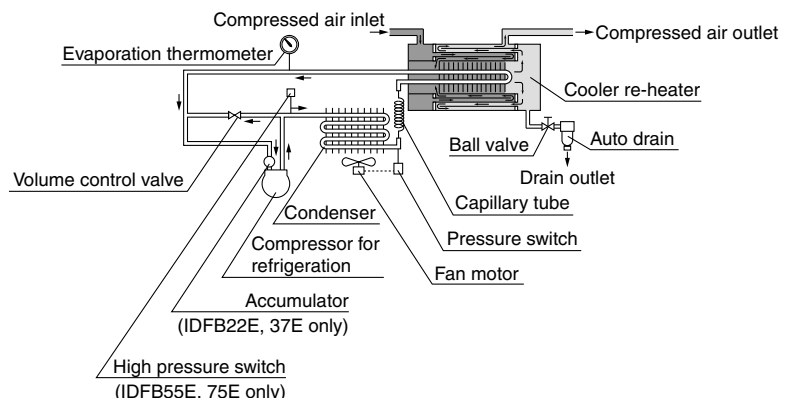

Series IDFB□E

Dimensions

IDFB22E, IDFB37E

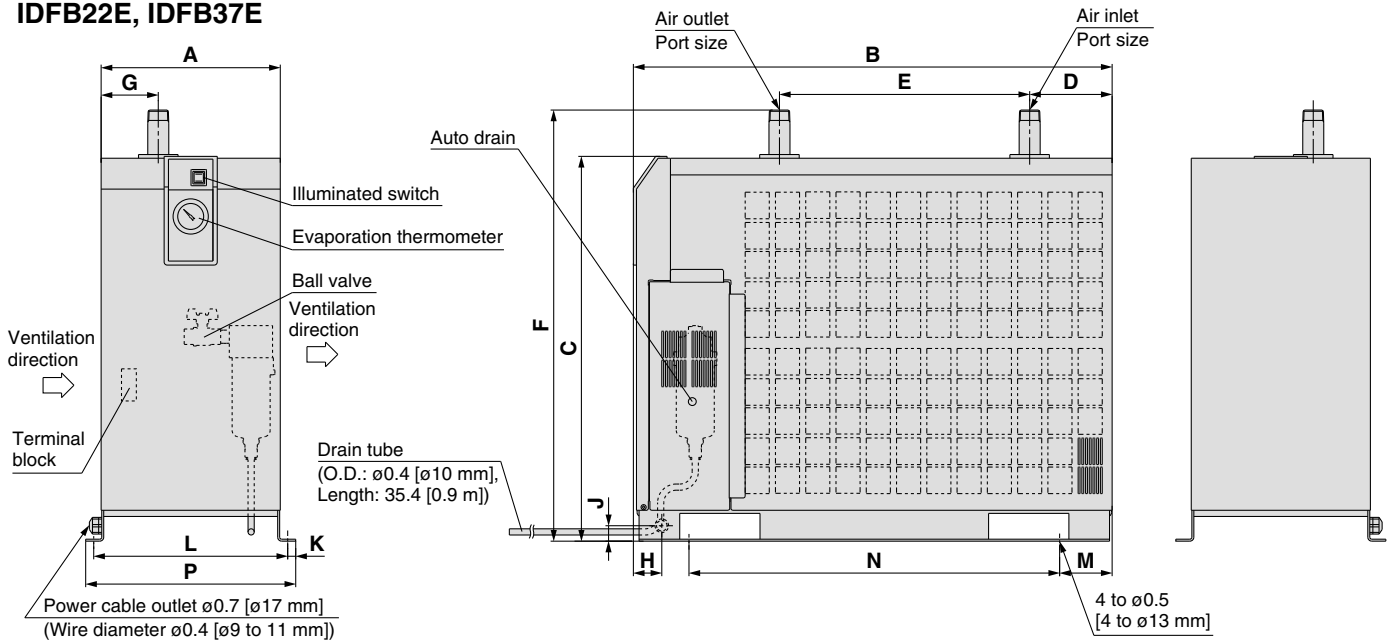

Dimensions

Unit: inch [mm]

Model	Port size	A	B	C	D	E	F	G	H	J	K	L	M	N	P
IDFB22E	1	11.4 [290]	30.5 [775]	24.5 [623]	5.3 [134]	15.9 [405]	27.5 [698]	3.7 [93]	1.8 [46]	1.0 [25]	0.5 [13]	12.4 [314]	3.3 [85]	23.6 [600]	13.4 [340]
IDFB37E	1½		33.7 [855]											26.8 [680]	

IDFB55E, IDFB75E

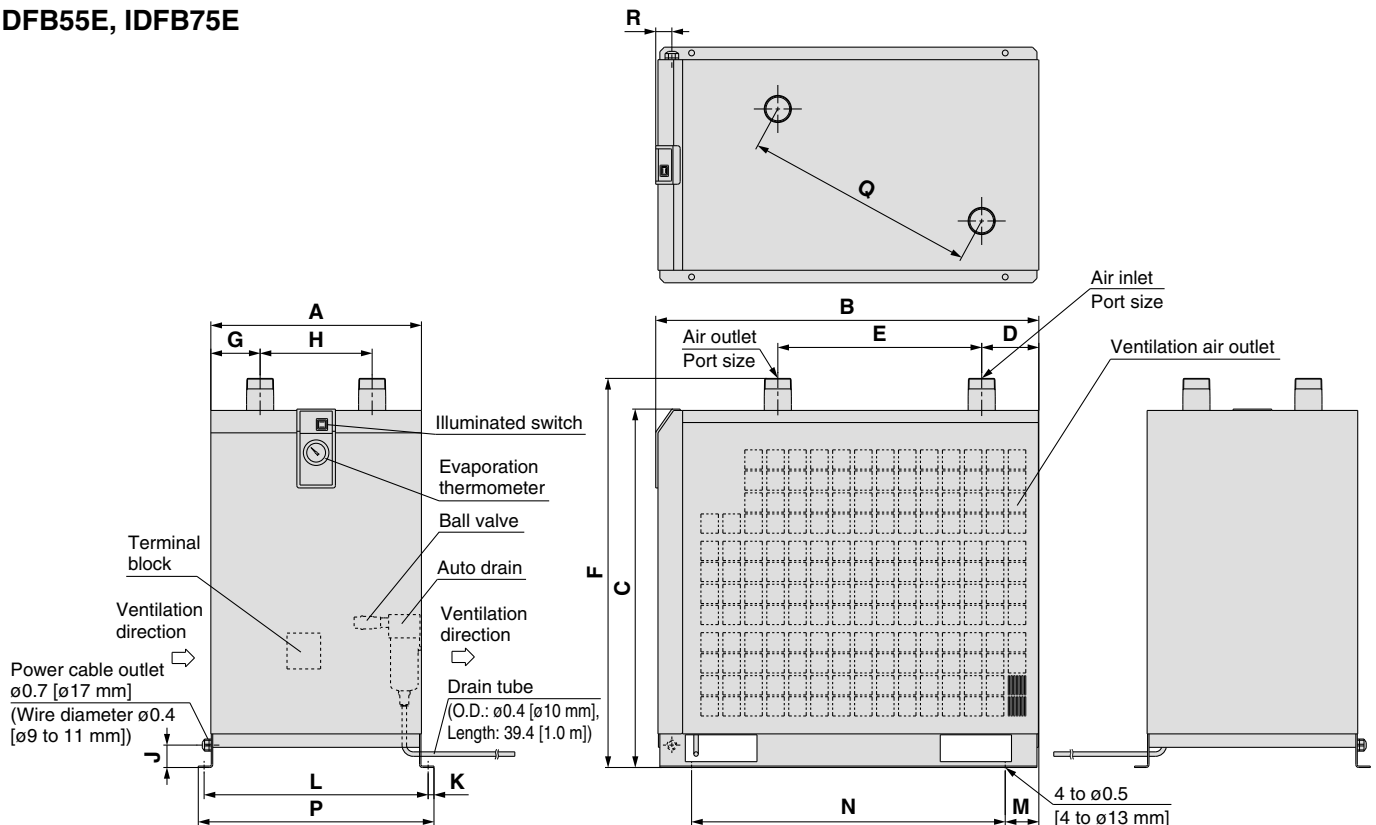

Dimensions

Unit: inch [mm]

Model	Port size	A	B	C	D	E	F	G	H	J	K	L	M	N	P	Q	R
IDFB55E	2	18.5 [470]	33.7 [855]	31.5 [800]	5.0 [128]	17.9 [455]	34.2 [868]	4.3 [110]	9.8 [250]	2 [50]	0.5 [13]	19.7 [500]	3.0 [75]	27.6 [700]	20.7 [526]	20.4 [519]	1.4 [36]
IDFB75E	2			35.4 [900]			38.1 [968]										

Series IDFB□E

Optional Specifications 1

Refer to “How to Order” pages 3 and 7 for optional models.

A Option symbol Cool compressed air output IDFB3E to 11E

There is no heating of cooled, dehumidified air as it leaves the air dryer. The air flow capacity with this option is smaller than that of the standard dryer. (The external dimensions are identical with the standard product.)
Note) Perform thermal insulation treatment for pipings and equipment installed after the dryer to prevent the formation of condensation.

Air Flow Capacity

Model	IDFB3E	IDFB4E	IDFB6E	IDFB8E	IDFB11E
Air flow capacity (ANR)	5 SCFM (8 m ³ /h)	13 SCFM (23 m ³ /h)	17 SCFM (29 m ³ /h)	19 SCFM (32 m ³ /h)	23 SCFM (39 m ³ /h)

Conditions: Inlet air pressure: 100 psi (0.7 MPa), Inlet air temperature: 100°F (37.8°C),
Outlet air temperature: 50°F (10°C), Ambient temperature: 100°F (37.8°C)

K Option symbol For medium air pressure (Auto drain bowl: Metal bowl with level gauge) IDFB6E to 37E

The auto drain is changed from the standard one to one with a medium pressure specification.
A metal bowl with a level gauge which can confirm the water level is used for the auto drain.

Specifications

1. Maximum operating pressure: 240 psi (1.6 MPa)
2. Dimensions ... same as standard products

Replacement Parts



Model	Auto drain assembly part no.	Note
IDFB6E to 15E-11N	IDF-S0201	The AD48-8Z-X2110 auto drain, insulator, and one-touch fitting are included.
IDFB22E, 37E-□N	AD48-8Z-X2110	One-touch fitting (KQ2H11-02S) is not included.
IDFB6E to 15E-11	IDF-S0086	The AD48-8-X2110 auto drain, insulator, and one-touch fitting are included.
IDFB22E, 37E-□	AD48-8-X2110	One-touch fitting (KQ2H10-02S) is not included.

L Option symbol With heavy duty auto drain (Suitable for medium air pressure) IDFB55E, 75E

More thorough drain discharge can be achieved by replacing the float type auto drain (used with standard equipment) with a heavy duty auto drain (ADH4000-04).
(The external dimensions are identical with the standard product.)

Maximum operating pressure: 240 psi (1.6 MPa)

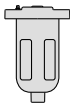
Replacement Parts

Model	Replacement part no. (Description)	Configuration
IDFB55E, 75E	ADH-E400 (Exhaust mechanism replacement kit)	 Exhaust mechanism replacement kit  Housing (a mounted unit is used)

R Option symbol With circuit breaker IDFB4E to 75E

A circuit breaker with cover is attached to the side of the air dryer. This saves additional electrical wiring at the time of installation.

IDFB4E to 15E

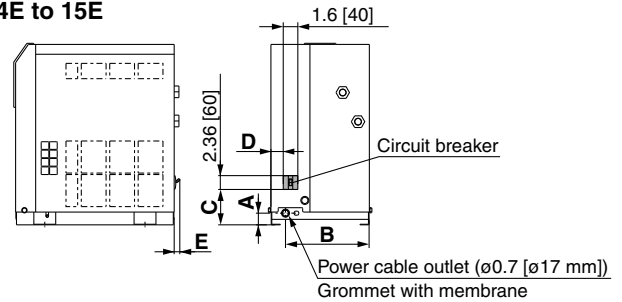

Dimensions

Model	A	B	C	D	E
IDFB4E, 6E, 8E, 11E	1.3 [32]	9.0 [230]	3.8 [97]	1.3 [34]	0.6 [15]
IDFB15E	1.7 [43]	10.2 [258]	4.0 [102]	3.2 [82]	—

IDFB22E to 75E

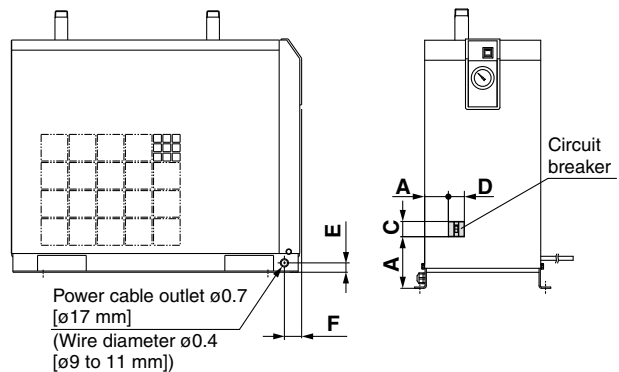

Dimensions

Model	A	B	C	D	E	F
IDFB22E, 37E	4.9 [125]	2.3 [59]	2.4 [60]	1.6 [40]	1 [25]	1.8 [46]
IDFB55E, 75E	5.7 [145]	2.2 [56]	3.8 [96]	2.4 [60]	2 [50]	1.4 [36]

Breaker Capacity and Sensitivity Current

Model	Breaker capacity	Sensitivity current
IDFB4E to 37E	15 A	30 mA
IDFB55E, 75E	10 A	30 mA

Optional Specifications 2

Refer to “How to Order” pages 3 and 7 for optional models.

T Option symbol
With terminal block for power supply, run & alarm signal and remote operation IDFB4E to 75E

In addition to the terminals for the power supply, terminals for the operating signal and the error signal are also available. (No-voltage contact)

Also, in case of remote control, operate it from the power supply side while the air dryer switch remains ON.

Contact capacity: 230 VAC, 4 A 24 VDC, 5 A for operating and error signals.

Minimum current value: 20 V, 5 mA (AC/DC) for operating and error signals.

Note) Please be sure to confirm the electric circuits with the drawings or instruction manual before using the output signal.

IDFB4E to 15E

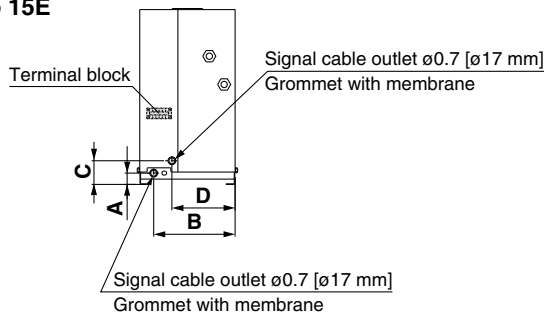

Dimensions Unit: inch [mm]

Model	A	B	C	D
IDFB4E, 6E, 8E, 11E	1.3 [32]	9.0 [230]	2.6 [67]	7.0 [179]
IDFB15E	1.7 [43]	10.2 [258]	3.0 [77]	6.2 [158]

IDFB22E to 75E

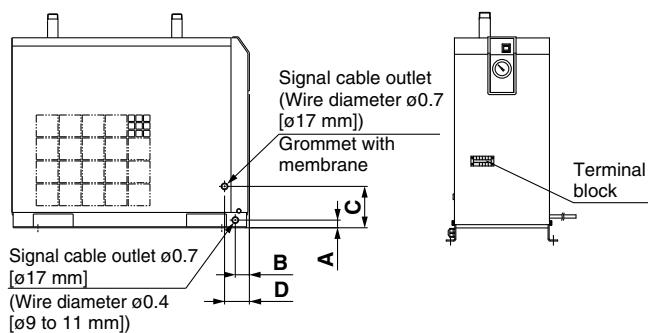

Dimensions Unit: inch [mm]

Model	A	B	C	D
IDFB22E, 37E	1 [25]	1.8 [46]	5.3 [135]	3.2 [81]
IDFB55E, 75E	2 [50]	1.4 [36]	10.6 [270]	

V Option symbol
Timer type solenoid valve with auto drain (Suitable for medium air pressure) IDFB4E to 75E

Drainage is discharged by controlling a solenoid valve with a timer. A strainer for solenoid valve protection and stop valve are also included. (The external dimensions are identical with the standard product.)

Maximum operating pressure: 240 psi (1.6 MPa)

* The timer type solenoid valve actuates once (for 0.5 seconds) every 30 seconds.

Replacement Parts

Model	Part no.	Note
IDFB4E to 22E-11□	IDF-S0199	115 VAC
IDFB22E, 37E-23□	IDF-S0198	230 VAC
IDFB55E, 75E-46□	IDF-S0302	230 VAC

Accessory (Option)

		Features	Specifications	Applicable dryer
Dust-protecting filter set		Prevents a decline in the performance of the air dryer, even in a dusty atmosphere.	Max. ambient temperature 104°F (40°C)	IDFB3E to 75E

How to Order

Dust-protecting filter set

IDF — FL 209

Applicable dryer

Symbol	Applicable dryer
209	IDFB3E
203	IDFB4E IDFB6E
204	IDFB8E
205	IDFB11E
206	IDFB15E
208	IDFB22E IDFB37E
213	IDFB55E
214	IDFB75E

Dust-protecting Filter Set/Dimensions

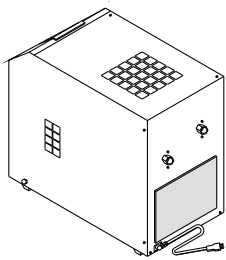

(IDF-FL209)

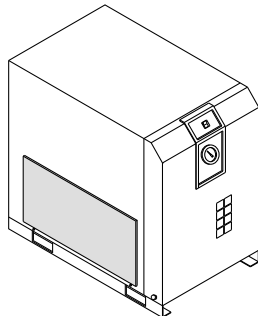

(IDF-FL203 to 208, 213, 214)

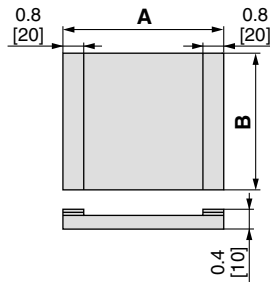

Dimensions

Unit: inch [mm]

Part no.	Applicable dryer	A	B	Mass lb [g]
IDF-FL209	IDFB3E	8.7 [220]	9.4 [240]	0.08 [35]
IDF-FL203	IDFB4E IDFB6E	14.8 [375]	7.7 [195]	0.12 [55]
IDF-FL204	IDFB8E	13.3 [340]	10.4 [265]	0.15 [70]
IDF-FL205	IDFB11E	14.8 [375]		0.17 [75]
IDF-FL206	IDFB15E	12.2 [310]	10.6 [270]	0.15 [70]
IDF-FL208	IDFB22E IDFB37E	21.7 [550]	14.4 [365]	0.31 [140]
IDF-FL213	IDFB55E	28.3 [720]	15.7 [400]	0.39 [175]
IDF-FL214	IDFB75E	24 [610]	22 [560]	0.42 [190]





Safety Instructions

These safety instructions are intended to prevent hazardous situations and/or equipment damage. These instructions indicate the level of potential hazard with the labels of “**Caution**,” “**Warning**” or “**Danger**.” They are all important notes for safety and must be followed in addition to International Standards (ISO/IEC), Japan Industrial Standards (JIS)*1) and other safety regulations*2).

- * 1) ISO 4414: Pneumatic fluid power – General rules relating to systems.
ISO 4413: Hydraulic fluid power – General rules relating to systems.
IEC 60204-1: Safety of machinery – Electrical equipment of machines. (Part 1: General requirements)
ISO 10218-1992: Manipulating industrial robots -Safety.
JIS B 8370: General rules for pneumatic equipment.
JIS B 8361: General rules for hydraulic equipment.
JIS B 9960-1: Safety of machinery – Electrical equipment of machines. (Part 1: General requirements)
JIS B 8433-1993: Manipulating industrial robots - Safety.
etc.
- * 2) Labor Safety and Sanitation Law, etc.

 **Caution:** Operator error could result in injury or equipment damage.

 **Warning:** Operator error could result in serious injury or loss of life.

 **Danger :** In extreme conditions, there is a possibility of serious injury or loss of life.

Warning

1. The compatibility of the product is the responsibility of the person who designs the equipment or decides its specifications.

Since the product specified here is used under various operating conditions, its compatibility with specific equipment must be decided by the person who designs the equipment or decides its specifications based on necessary analysis and test results. The expected performance and safety assurance of the equipment will be the responsibility of the person who has determined its compatibility with the product. This person should also continuously review all specifications of the product referring to its latest catalog information, with a view to giving due consideration to any possibility of equipment failure when configuring the equipment.

2. Only personnel with appropriate training should operate machinery and equipment.

The product specified here may become unsafe if handled incorrectly. The assembly, operation and maintenance of machines or equipment including our products must be performed by an operator who is appropriately trained and experienced.

3. Do not service or attempt to remove product and machinery/equipment until safety is confirmed.

1. The inspection and maintenance of machinery/equipment should only be performed after measures to prevent falling or runaway of the driven objects have been confirmed.

2. When the product is to be removed, confirm that the safety measures as mentioned above are implemented and the power from any appropriate source is cut, and read and understand the specific product precautions of all relevant products carefully.

3. Before machinery/equipment is restarted, take measures to prevent unexpected operation and malfunction.

4. Contact SMC beforehand and take special consideration of safety measures if the product is to be used in any of the following conditions.

1. Conditions and environments outside of the given specifications, or use outdoors or in a place exposed to direct sunlight.

2. Installation on equipment in conjunction with atomic energy, railways, air navigation, space, shipping, vehicles, military, medical treatment, combustion and recreation, or equipment in contact with food and beverages, emergency stop circuits, clutch and brake circuits in press applications, safety equipment or other applications unsuitable for the standard specifications described in the product catalog.

3. An application which could have negative effects on people, property, or animals requiring special safety analysis.

4. Use in an interlock circuit, which requires the provision of double interlock for possible failure by using a mechanical protective function, and periodical checks to confirm proper operation.



Safety Instructions

Caution

The product is provided for use in manufacturing industries.

The product herein described is basically provided for peaceful use in manufacturing industries.

If considering using the product in other industries, consult SMC beforehand and exchange specifications or a contract if necessary. If anything is unclear, contact your nearest sales branch.

Limited Warranty and Disclaimer/Compliance Requirements

The product used is subject to the following “Limited Warranty and Disclaimer” and “Compliance Requirements”. Read and accept them before using the product.

Limited Warranty and Disclaimer

1. The warranty period of the product is 1 year in service or 1.5 years after the product is delivered.*3)

Also, the product may have specified durability, running distance or replacement parts. Please consult your nearest sales branch.

2. For any failure or damage reported within the warranty period which is clearly our responsibility, a replacement product or necessary parts will be provided.

This limited warranty applies only to our product independently, and not to any other damage incurred due to the failure of the product.

3. Prior to using SMC products, please read and understand the warranty terms and disclaimers noted in the specified catalog for the particular products.

*** 3) Vacuum pads are excluded from this 1 year warranty.**

A vacuum pad is a consumable part, so it is warranted for a year after it is delivered.

Also, even within the warranty period, the wear of a product due to the use of the vacuum pad or failure due to the deterioration of rubber material are not covered by the limited warranty.

Compliance Requirements

When the product is exported, strictly follow the laws required by the Ministry of Economy, Trade and Industry (Foreign Exchange and Foreign Trade Control Law).



Series IDFB□E

Specific Product Precautions 1

Be sure to read this before handling. For Air Preparation Equipment Precautions, refer to “Precautions for Handling Pneumatic Devices” (M-03-E3A).

Installation

⚠ Caution

- Avoid locations where the air dryer will be in direct contact with wind and rain. (Avoid locations where relative humidity is greater than 85%.)
- Avoid exposure to direct sunlight.
- Avoid locations that contain much dust, corrosive gases, or flammable gases. Failure due to corrosion is not covered under warranty.
- Avoid locations of poor ventilation and high temperature.
- Allow ample space around the air dryer.
- Avoid locations where a dryer could draw in high temperature air that is discharged from an air compressor or other dryer.
- Avoid locations subjected to vibration.
- Avoid possible locations where the drain can freeze.
- Use the air dryer with an ambient temperature lower than 104°F (40°C).
- Avoid installation on machines for transporting, such as trucks, ships, etc.

Drain Tube

⚠ Caution

- A polyurethane tube is attached as a drain tube for the IDFB3E to 75E. Use this tube to discharge drainage.
- Do not use the drain tube in an upward direction. Do not bend or crush the drain tube. (The auto drain will not be activated and water will try to escape via the air outlet.)

Power Supply

⚠ Caution

- Connect the power supply to the terminal block.
- Install a suitable circuit breaker applicable for the specific model.
- The voltage fluctuation should be maintained within $\pm 10\%$ of the rated voltage.

Air Piping

⚠ Caution

- Be careful to avoid an error in connecting the air piping at the compressed air inlet (IN) and outlet (OUT).
- Install by-pass piping since it is needed for maintenance.

IDFB3E

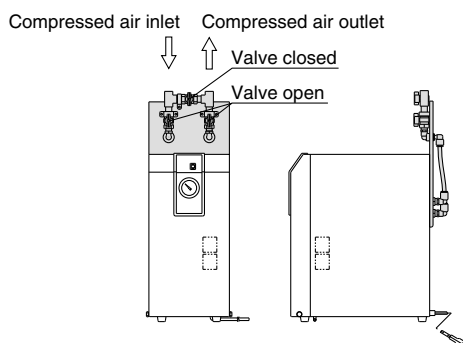

Air Piping

⚠ Caution

IDFB4E to 15E

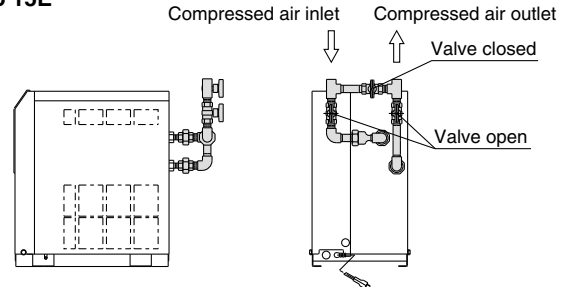

IDFB22E, 37E

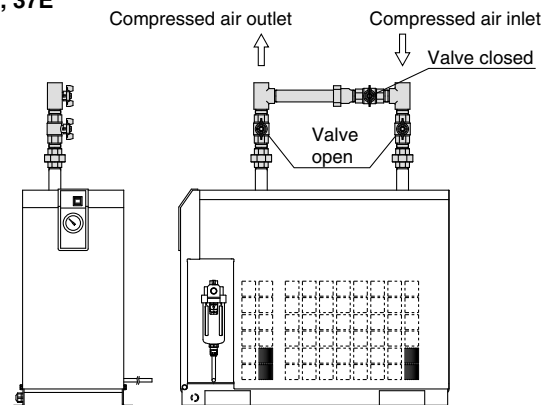

IDFB55E, 75E

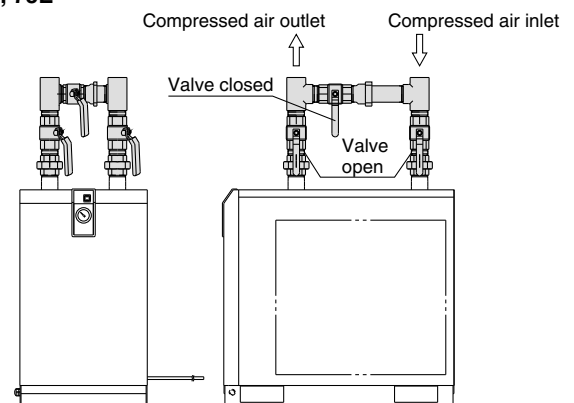

- When tightening piping at the air inlet/outlet tube, the hexagonal parts of the port on the air dryer side or piping should be held firmly with a spanner or adjustable angle wrench.
- Variations in operating conditions may cause condensation to form at the surface of the outlet piping. Apply thermal insulation around the piping to prevent condensation from forming.
- Vibration resulting from the compressor should not be transmitted through air piping to the air dryer.
- Do not allow the weight of the piping to lie directly on the air dryer.



Series **IDFB□E**

Specific Product Precautions 2

Be sure to read this before handling. For Air Preparation Equipment Precautions, refer to “Precautions for Handling Pneumatic Devices” (M-03-E3A).

Protection Circuit

Caution

When the air dryer is operated under the following stated conditions, a protection circuit is activated, the light turns off and operation stops.

- When the compressed air temperature is too high.
- When the compressed air flow rate is too high.
- When the ambient temperature is too high. (104°F (40°C) or higher)
- When the fluctuation of the power supply is beyond the rated voltage $\pm 10\%$.
- When the dryer is drawing in high temperature air that is discharged from an air compressor or other dryer.
- The ventilation port is obstructed by a wall or clogged with dust.

Compressor Air Delivery

Caution

Use the air compressor with an air delivery of 3.5 SCFM (6 m³/h) or larger for the IDFB3E to 75E series.

Since the auto drain of the IDFB3E to 75E series is designed in such a way that the valve remains open unless the air pressure rises to 22 psi (0.15 MPa) or higher, air will blow out from the drain discharge port when the air compressor starts up until the pressure increases. Therefore, if the air compressor has a small air delivery, the pressure may not be sufficient.

Auto Drain

Caution

The auto drain may not function properly, depending on the quality of the compressed air. Check the operation once a day.

Cleaning of Ventilation Area

Caution

Remove dust from the ventilation area once a month using a vacuum cleaner or an air blow nozzle.

Time Delay for Restarting

Caution

Allow at least three minutes before restarting the dryer. If the air dryer is restarted within three minutes after being stopped, the protection circuit will be activated, operating light will turn off and the dryer will not be activated.

Related Products

Membrane Air Dryer *Series IDG*

(For use in cases where a power supply is not provided)

Dew point indicator for checking air drying condition at a glance

(Except IDG1)
(The IDG3, IDG5, IDG3H, IDG5H are semi-standard.)

- Compact
- Lightweight
- Space-saving

Fitting for discharging purge air available

Purge air can be discharged with a tube if it should not be discharged around the membrane air dryer (semi-standard).

Discharged air noise reduced with built-in silencer

[Except IDG1, IDG3, IDG3H, IDG5, IDG5H, IDG30, IDG30H, IDG30L, IDG50, IDG50H, IDG50L]



No need for a power supply

A power supply is not necessary at all. Saves time and effort for wiring, and there is no need to consider electrical standards.

No vibration nor heat discharge

No mechanically moving parts such as refrigerator

Suitable for a low dew point

Outlet air atmospheric pressure dew point: -40°C

[IDG30L, IDG50L, IDG60L]
[IDG75L, IDG100L]

Outlet air atmospheric pressure dew point: -60°C

[IDG60S, IDG75S, IDG100S]

**Outlet air flow rate
10 to 1000 ℓ/min (ANR)**

* See separate catalog.

Heatless Air Dryer *Series ID*

(For use in cases where a low dew point is necessary)

Heatless type ID series is ideal for applications that require dry air with a low dew point.

Supplies dry air with a low dew condensation point of -30°C or less.

Small and light without heater and electric control panel



Possible to check outlet dew point with indicator

(Self-regenerative style allows easy maintenance.)

**Outlet air flow rate
80 to 780 ℓ/min (ANR)**

* See separate catalog.

Record of changes

B edition * Addition of Refrigerated Air Dryers IDFB55E, 75E.
* Number of pages from 20 to 24.

MQ



Safety Instructions

Be sure to read "Precautions for Handling Pneumatic Devices" (M-03-E3A) before using.

SMC Corporation

Akihabara UDX 15F,
4-14-1, Sotokanda, Chiyoda-ku, Tokyo 101-0021, JAPAN
Phone: 03-5207-8249 Fax: 03-5298-5362
URL <http://www.smcworld.com>
© 2008 SMC Corporation All Rights Reserved

Specifications are subject to change without prior notice
and any obligation on the part of the manufacturer.

D-DN

1st printing KZ printing MQ 13500DN Printed in Japan.

This catalog is printed on recycled paper with concern for the global environment.